



ELECTRIC CURTAIN SYSTEM

KOPER_k

MP82

CURTAIN MOTOR

KOPER[®]

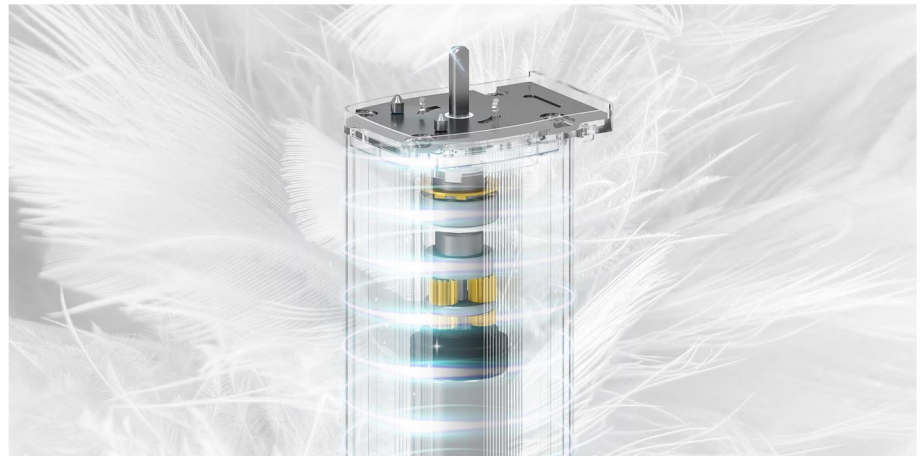
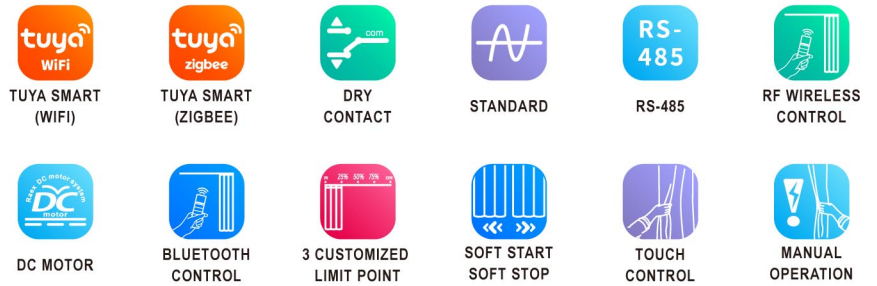

RATED VOLTAGE	100-240V AC			
RATED FREQUENCY	50/60Hz			
RATED CURRENT	≤0.3A			
RATED TORQUE	1.2N·m			
RATED SPEED	75/90/110rpm			
WORKING SYSTEM	S3 50%			
IP GRADE	IP41			
NOISE	<30dB			
SIZE	71×50.6×284mm			71×50.6×304mm
PRODUCT CODE	10003452 MP82	10003462 MP82 TUYA WIFI	10003463 MP82 TUYA ZIGBEE	10003465 MP82 STANDARD
FUNCTION	RF wireless control Dry contact	TUYA SMART (WiFi) BT wireless control Dry contact	TUYA SMART (Zigbee) BT wireless control Dry contact	Standard RS-485 RF wireless control Dry contact

MP82

ELECTRIC CURTAIN SYSTEM | SYSTEM STRUCTURE ANALYSIS GRAPHICS

KOPER.

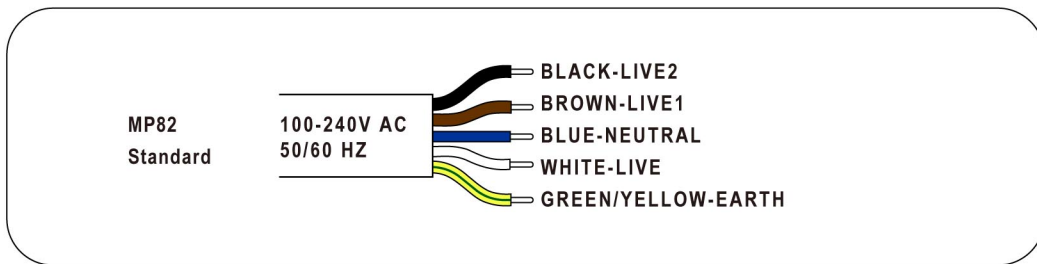
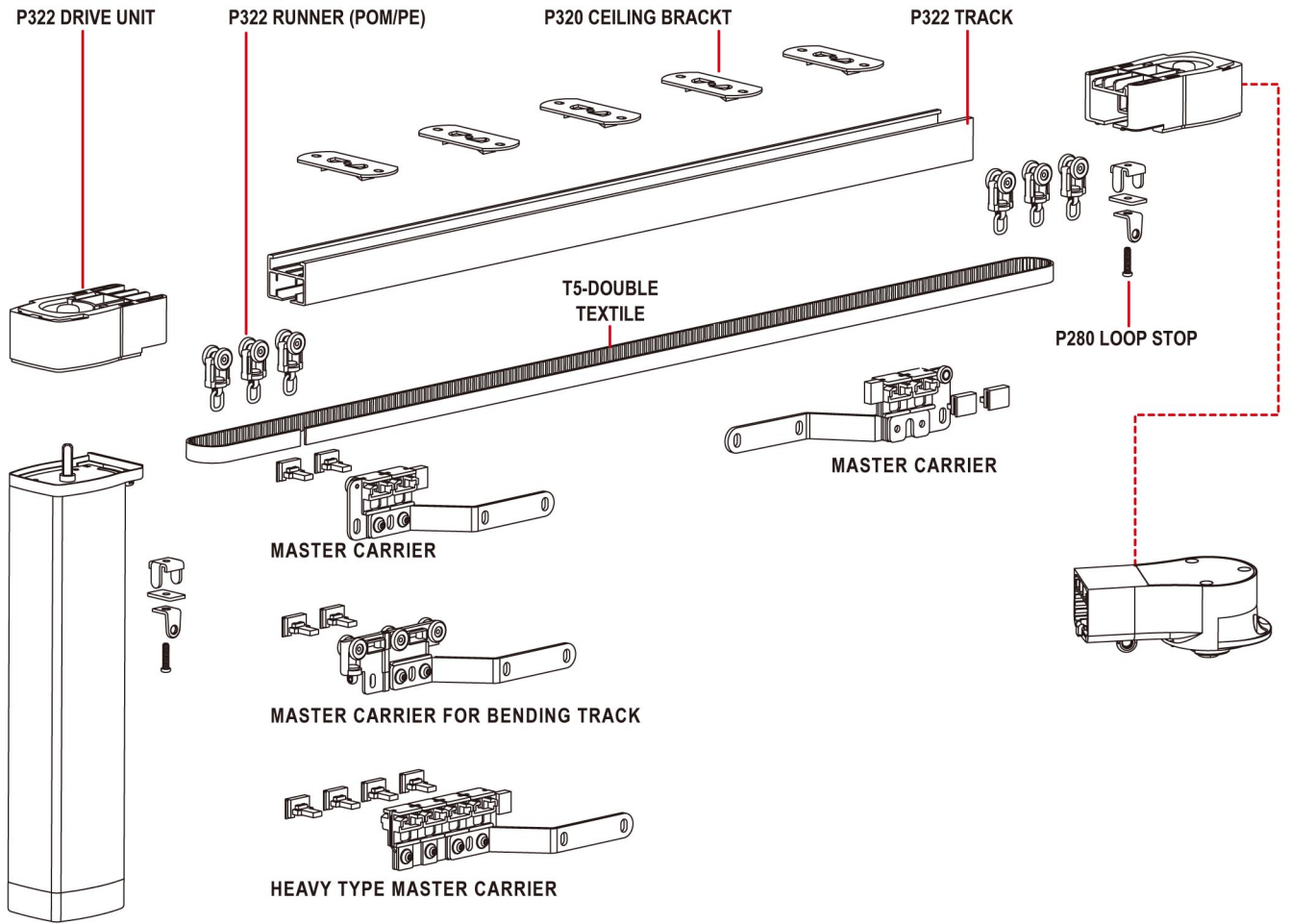

MP82(1.2N·m)

P322 TRACK	CURVATURE RADIUS	4m	6m	8m	12m
	-	50kg	40kg	30kg	20kg
	R400	40kg	30kg	20kg	-
	R2000	40kg	30kg	20kg	-
	R400×2	25kg	20kg	-	-

ONE LINE TELESCOPIC CURTAIN TRACK

P35 TRACK



SIZE	1.8m-3m	2.3m-4m	2.5m-4.5m
PRODUCT CODE	P35-3M	P35-4M	P35-4.5M
↔	30kg		

IDLER UNIT



TRANSITION COMPONENT

82 DRIVE UNIT

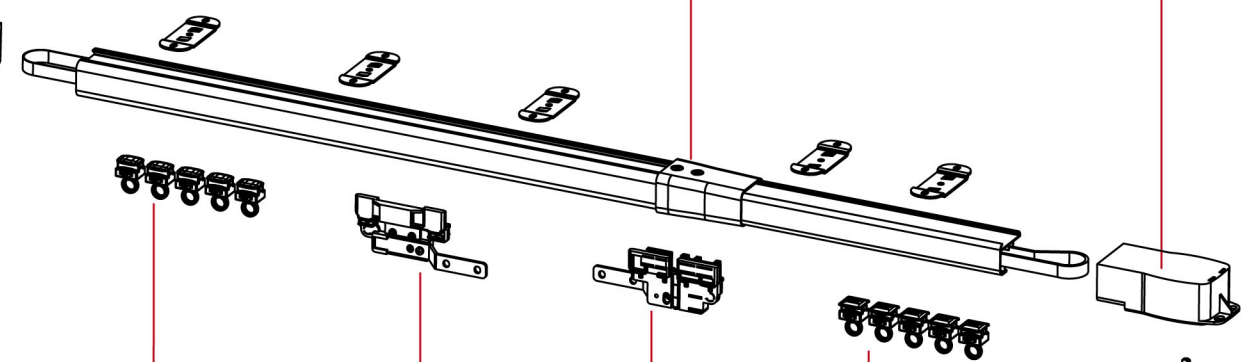

THICKENED SILENT SLIDER

CARRIER-A

CARRIER-B

THICKENED SILENT SLIDER

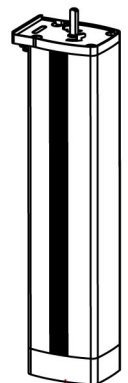

MP82

ONE LINE TELESCOPIC CURTAIN TRACK



1.8M-3M | 2.3M-4M | 2.5M-4.5M
70.87in-118.11in | 90.55in-157.48in | 98.43in-177.16in

① Adjust the length of the track.

Loosen the "+" type screws on the transition component, hold the tracks on both sides, and stretch them to the required size. It is recommended to leave about 2cm between the unit and the wall.

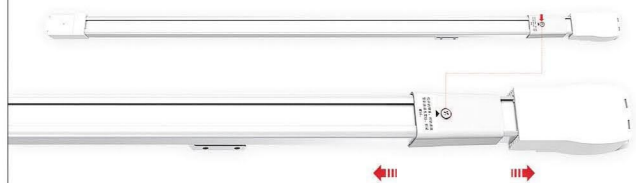

② Install the slider ring.

Press along the V-shaped groove of the slider, and the slider ring will be locked. The installation of the slider ring is complete. (Modular block combination slider, suitable)

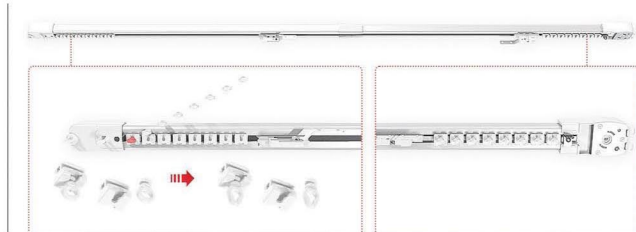

③ Align carrier.

Firstly, locate the screws on the upper row of carrier and loosen them. Put both carriers to the edge of the unit and tighten the screws on carrier. Afterwards, pull on the carrier to confirm if it is running smoothly.



CONTORLLER SYSTEM



WIRELESS REMOTE CONTROL



PRODUCT CODE	YR2118	YR2119
RECEIVE CHANNEL	6CH	20CH
BATTERY	CR2032*1pc	
RECEIVE FREQUENCY	433.92MHz±75KHz (ASK)	
TRANSMIT DISTANCE	≤30m(Indoor)	
SIZE	141×41×13mm	